

PF12⁺

Wiring

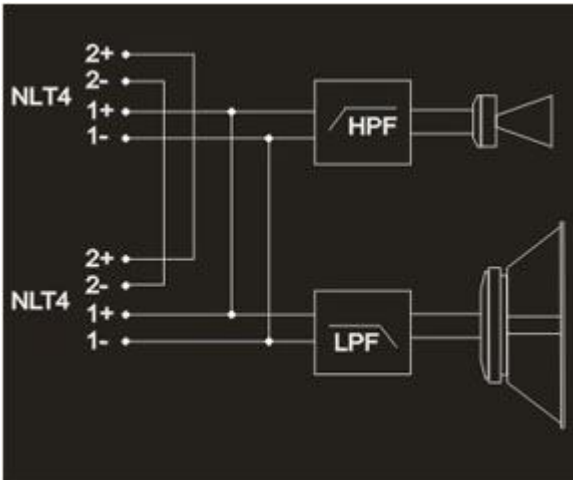

Frequency Response

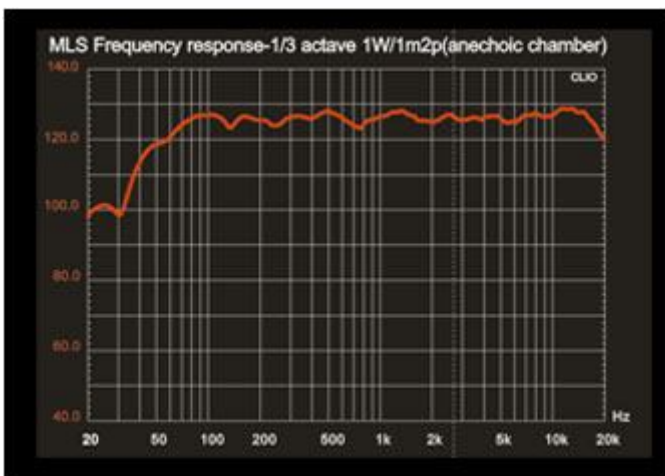

Drawing

